

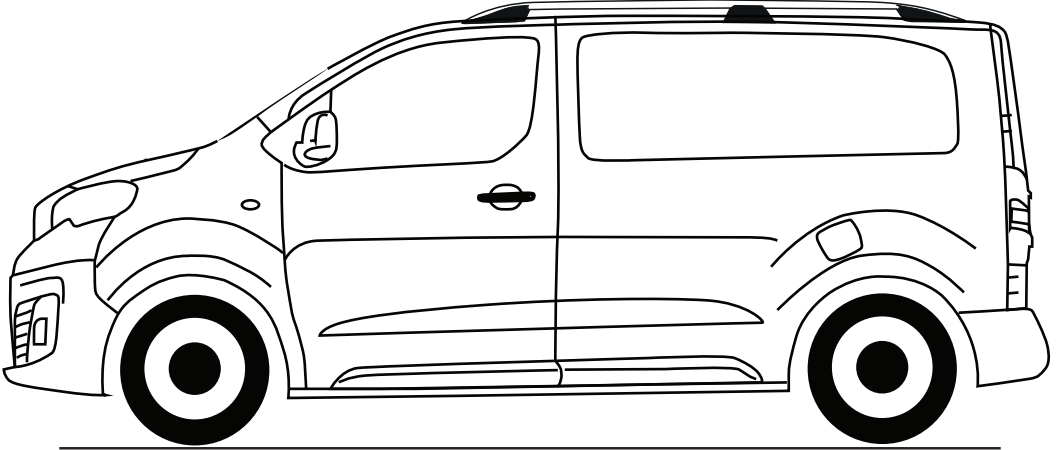

ONTEC
AUTO ACCESSORIES.CO



**CITROEN JUMPY (L2-L3) 2016 +
PEUGEOT EXPERT (L2-L3) 2016 +
TOYOTA PROACE (L2-L3) 2016 +**

TR	Montaj Talimatı :	PORT BAGAJ
GB	Fitting Instructions :	ROOF RACK
D	Montageanleitung :	DACHRELING
F	Instructions de Montage :	RIDELLES DE TOIT

TR

*Port bagaj taşıma kapasitesi 75 kg. olup; yükleme yapmadan önce aracın tavan taşıma kapasitesinin dikkate alınması gerekir.

GB

*Roof Rack carrying capacity is maximum 75 kg. Please check your vehicle roof maximum carrying capacity from your car manufacturer before load roof rack.

G

*Maximale Traglast unsere Dachrelinge betragen 75kg. Die freigegebenen Dachlasten der Fahrzeughersteller dürfen nicht überschritten werden. Bitte zur Kenntnisnahme!

F

*La capacité de chargement maximale est de 75 Kg. Nous vous prions de vérifier la capacité de chargement du toit de votre véhicule avant de charger les barres de toit.



30 Min.

①



PARÇA LİSTESİ

Part List / Teileliste / Lista de accesorios

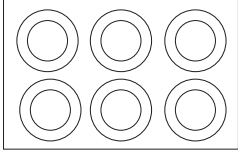

- (TR) PUL = 6 PARÇA
(GB) RING WASHER = 6 PIECES
(D) UNTERLEGSCHLEIBE = 6 STÜCK
(F) RONDELLE AUTOBLOQUANTE = 6 PIÈCES

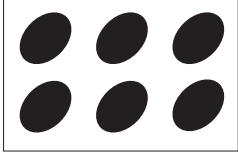

- (TR) PLASTİK TAPA = 6 PARÇA
(GB) PLASTIC PLUG = 6 PIECES
(D) GUMMISTOPFEN = 6 STÜCK
(F) BOUCHON PLASTIQUE = 6 PIÈCES

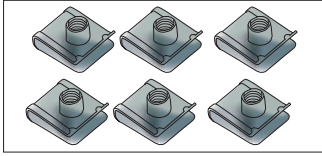

- (TR) KLİPSLİ SOMUN = 6 PARÇA
(GB) CLIPS = 6 PIECES
(D) CLIPS = 6 STÜCK
(F) CLIPS = 6 PIÈCES

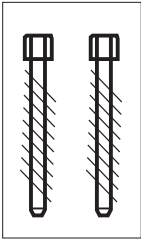
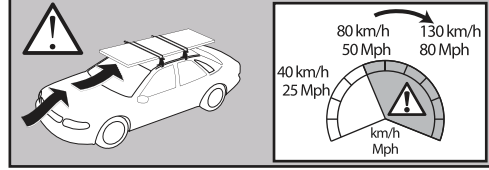
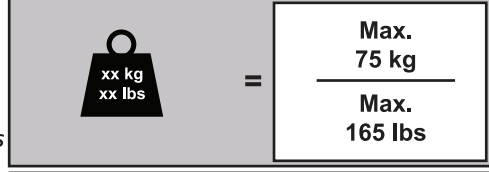

m-6 x 30 (FRONT 2 PIECES)

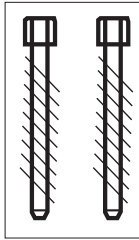

m-6 x 55 (MIDDLE 2 PIECES)

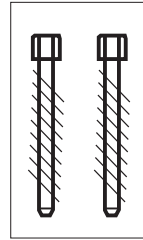

m-6 x 30 (REAR 2 PIECES)

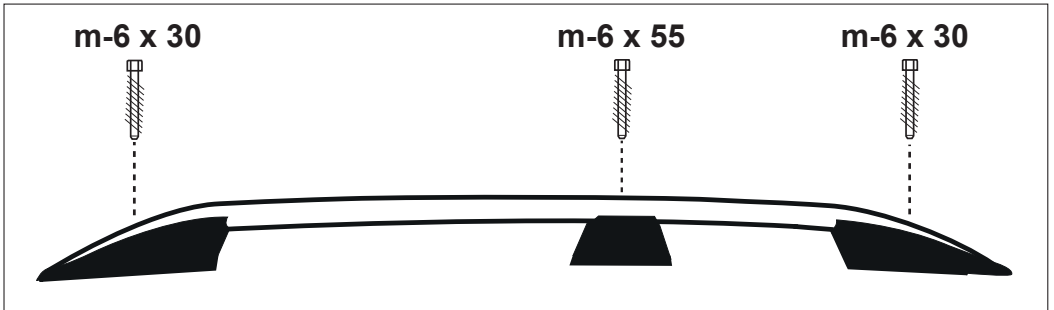

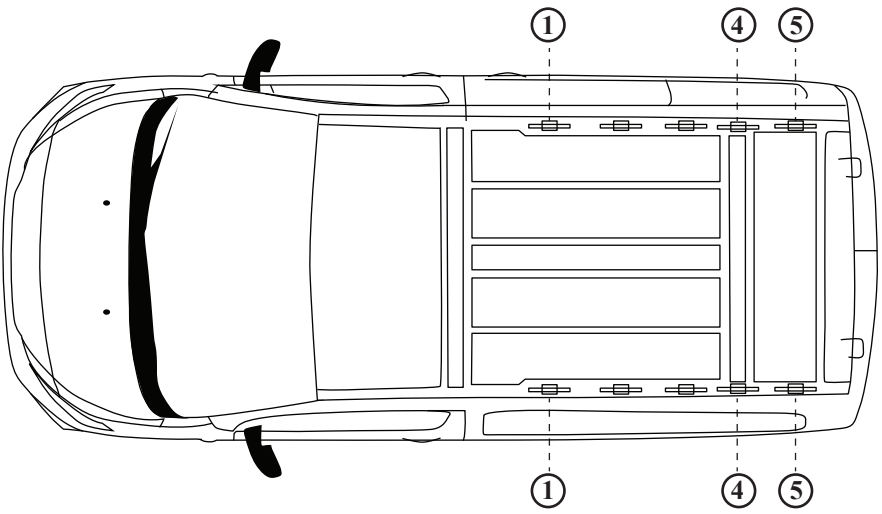

1) 1- 4 ve 5 Numaralı yerlere klipsli somunları takınız.

1) Please place clips to the indicated areas numbered as 1, 4 and 5

1) Bitte legen Sie die Clips an die angegebenen Stellen die in der Skizze angedeutete wurde Nr. 1, 4 und 5.

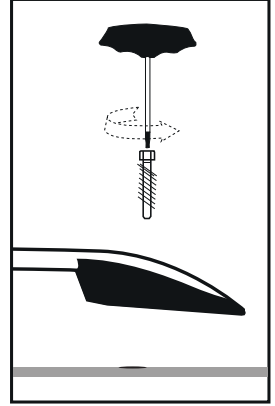
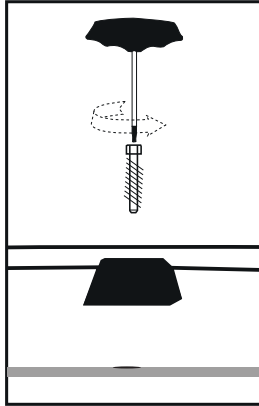
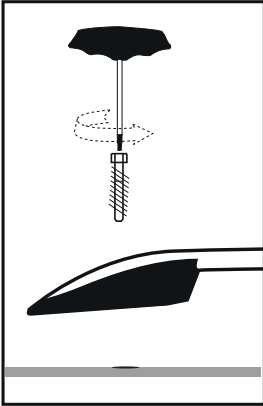
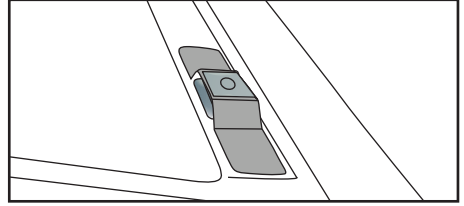
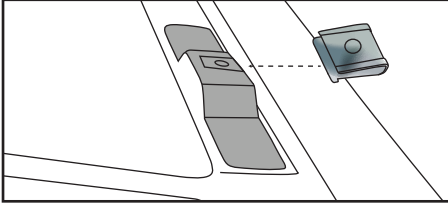

2) Port Bagajı araç üzerine montaj yerlerinden sabitleyip sıkınız.

2) Please attach bolts to the holes and tighten them all carefully.

2)Fixieren Sie den Dachträger an den Montierstellen und befestigen Sie diesen.

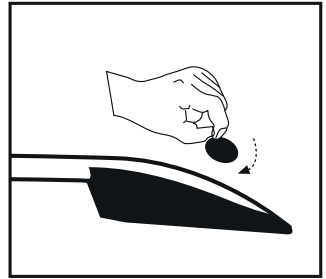
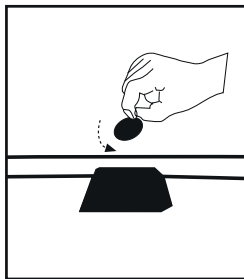
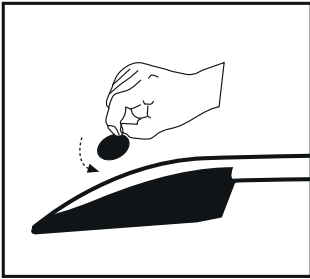
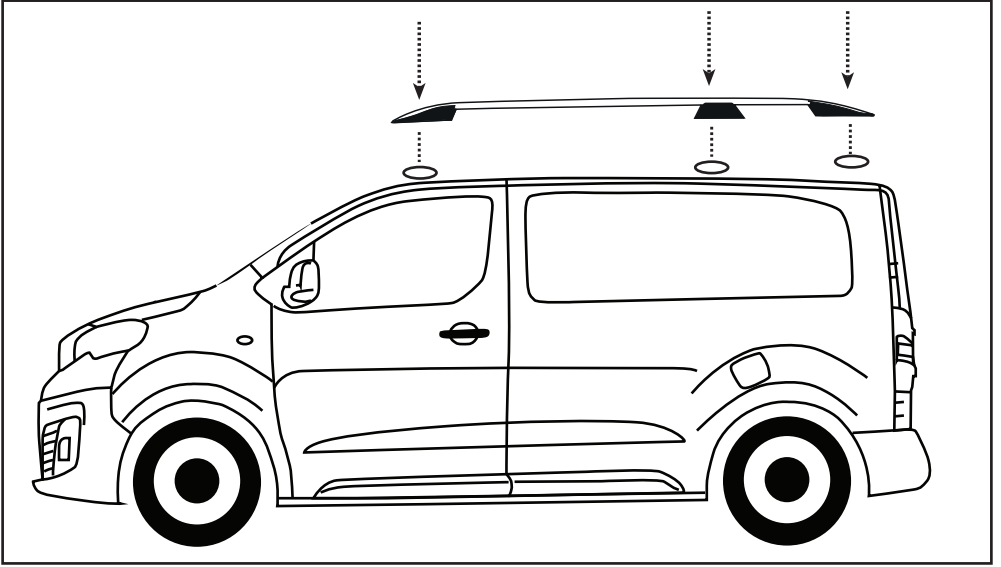

3)Port Bagajın tapalarını yerlerine yerleştirerek montajı tamamlayınız.

3)Tap the plugs on roof rails.

3)Stecken Sie die Stopper in Ihre Plätze und schließen Sie diese.